

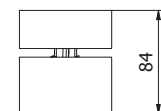

Возможность регулировки наклона

Светоотдача 85 lm/W

Угол свечения 36°

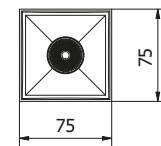

LD-BNC8WKB-NB

8 W

● 4000 K

680 lm

белый

алюминий

320 гр

LD-BNC8WKC-NB

черный



Возможность регулировки наклона светильника

Светоотдача 85 lm/W

Угол свечения 36°

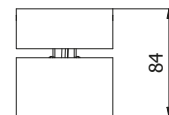
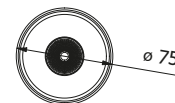

LD-BNC8WOB-NB

8 W

● 4000 K

680 lm

белый

алюминий

320 гр

LD-BNC8WOC-NB

черный



Светоотдача 100 lm/W

Угол свечения 36°

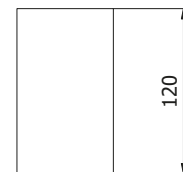
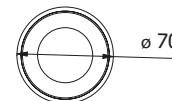

LD-PRM10WB-NB	10 W	● 4000 K	1000 lm	белый	алюминий	260 гр
LD-PRM10WC-NB				черный		
LD-PRM10WS-NB				серый		





Для использования с источником GU10

Мах. 20W

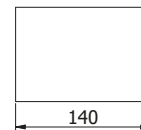
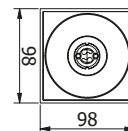

OS-TENGU10KW-10	max 20 W	белый	алюминий	425 гр
OS-TENGU10KW-00		черный		



Для использования с источником GU10

Мах. 20W

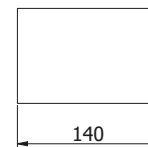

OS-TENGU10-10	max 20 W	белый	алюминий	425 гр
OS-TENGU10-00		черный		



Для использования с источником GU10

Мах. 20W

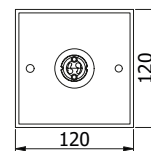
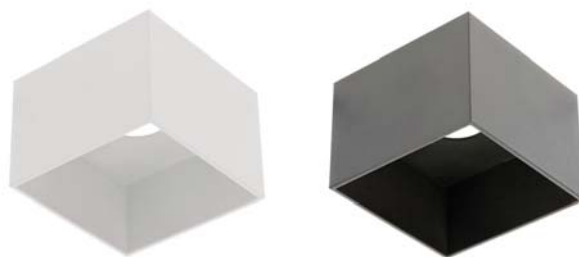

OS-SAKES111KW-10	мах 20 W	белый	алюминий	550 гр
OS-SAKES111KW-00		черный		



Для использования с источником GU10

Мах. 20W

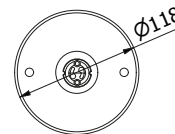

OS-SAKES111-10	мах 20 W	белый	алюминий	350 гр
OS-SAKES111-00		черный		



Линейный светильник LED OMEGA

доступен от марта

➤ Непосредственный монтаж на потолке или форме).

➤ Монтаж на кабеле (отсутствует в комплекте).

➤ Светоотдача 90 lm/W

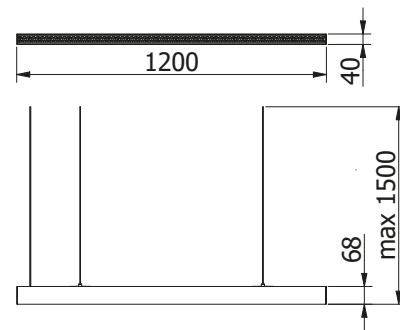

Продукт для:
стальной трос
OS-HERZW1-00



LD-OME50WNB-10-A	с питанием	50 W	● 4000 K	4500 lm	белый	алюминий + PC	1420 гр
LD-OME50WNB-10-C	без питания						



Длина оправы = 120 см

Соединитель L i T = 30 см

Дает возможность создавать прямоугольники:

60 см x 120 см, 180 см x 240 см, 60 см x 240 см

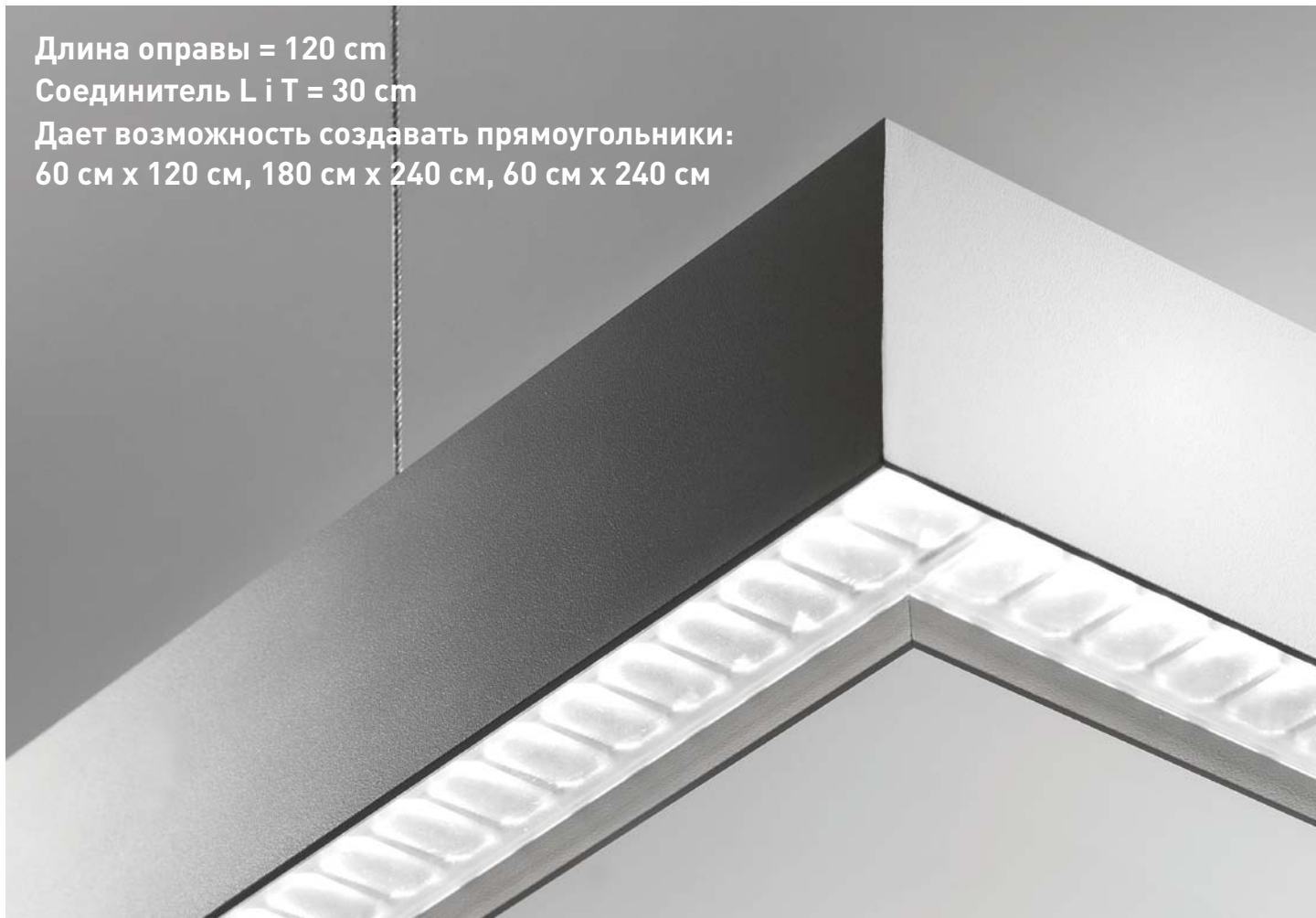



LD-OME30WNB-10-L



LD-OME30WNB-10-T



LK-OMEGA-OP



LD-OME30WNB-10-L	30 W	● 4000 K	2700 lm	белый	алюминий + PC	940 гр
LD-OME30WNB-10-T						1060 гр
LK-OMEGA-OP	-	-	-	-	сталь	100 гр



➤ Монтаж непосредственно на потолке или в форме Висящий на тресе (отсутствует в комплекте).

➤ Возможность соединять в прямые линии

➤ Светоотдача 80 lm/W



Продукт для стального кабеля OS-HERZW1-00



LD-LUN40WNB-10-A

40 W

● 4000 K

3200 lm

белый

алюминий + PC

1450 гр

LD-LUN40WNB-00-A

черный





Потолочный светильник LED LIVIA

доступен от марта

В комплекте стальные тросы

Светоотдача 90 lm/W

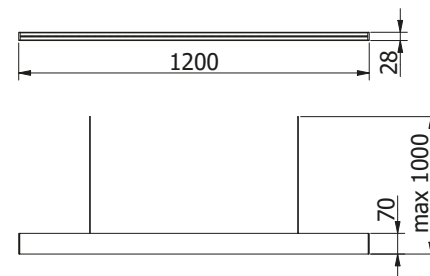

LD-LIV40WNB-10

40 W

● 4000 K

3600 lm

белый

алюминий

1300 гр

LD-LIV40WNB-00

черный

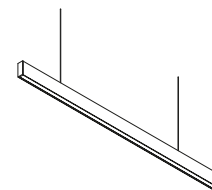

Подвесной светильник LED VILANA

доступен от февраля



В комплекте стальные тросы

Двухсторонний светильник

Светоотдача 90 lm/W

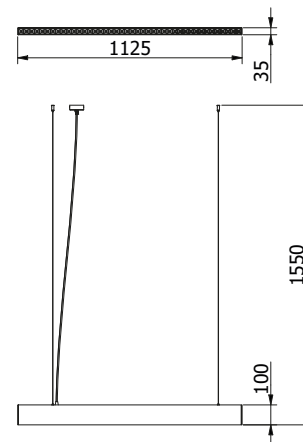
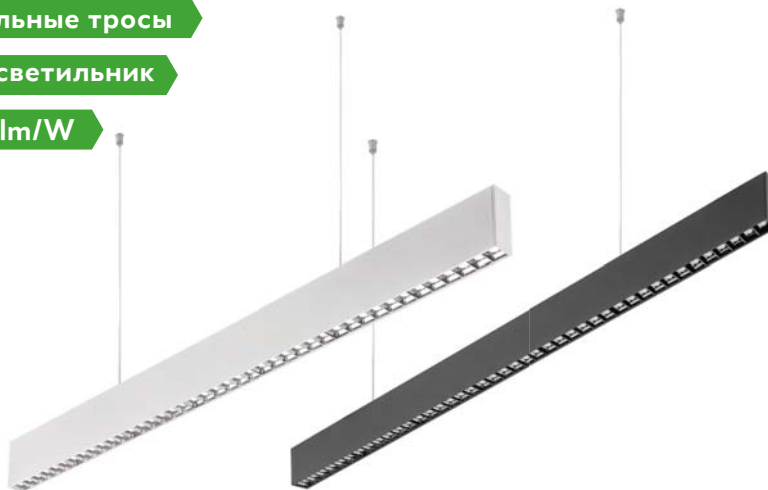

LD-VIL42WUDB-NB

42 W

4000 K

3780 lm

белый

алюминий

2100 гр

LD-VIL42WUDC-NB

черный



Указанные сроки доступности могут быть изменены

Минималистский и современный дизайн - ультра тонкий корпус 34 мм

В комплекте стальные тросы



LD-FRT36WB-NB

36 W

● 4000 K

2900 lm

белый

алюминий

3300 гр





Для маскировки потолочных висящих светильников

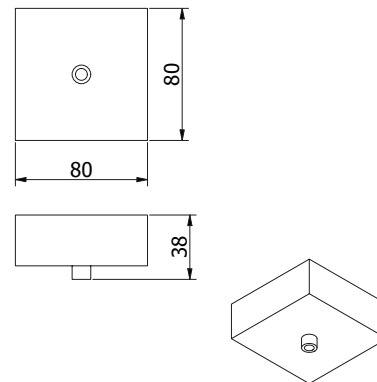
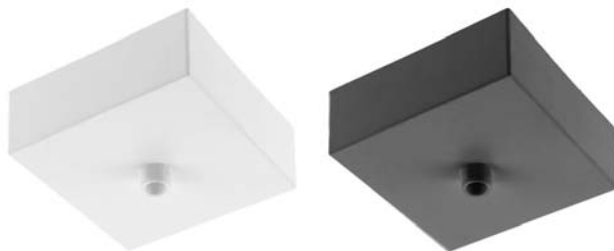

AE-MAS80X80-10

AE-MAS80X80-00

50W

пластик

90 гр

Светодиодный трековый светильник COB ZOOM LINE

доступны от февраля

Регуляция угла освещения от 15° до 38°

Светоотдача 100 lm/W

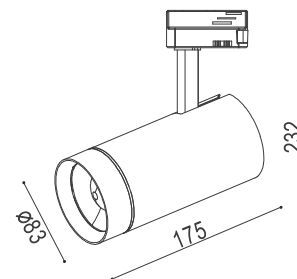

ZLD-30W1538ZLN-NB0

30 W

4000 K

3000 lm

белый

алюминий

15-38°

940 гр

ZLD-30W1538ZLN-NB1

черный



Указанные сроки доступности могут быть изменены



Современная конструкция, которая уменьшает температуру диодов LED и лучше рассеивает тепло

IP20 / 44

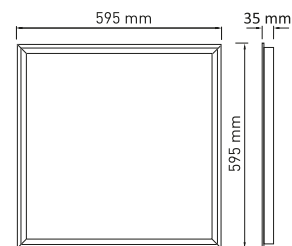

LD-LN40W60UGR-NB

40 W

● 4000 K

3400 lm

алюминий +
пластик

белый







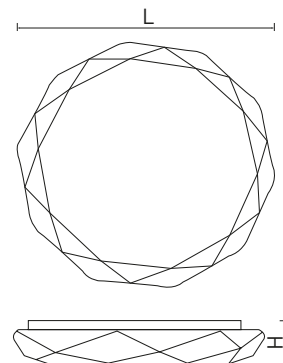

1720 гр





Надежный алюминиевый крепеж



								
LD-STARS24W-NB	24 W	● 4000 K	1800 lm	PC + металл	LxWxH mm	ø410 × 105	белый	PF > 0,9
LD-STARS48W-NB	48 W		3600 lm			ø510 × 110		





Светоотдача 90 lm/W

IP 54

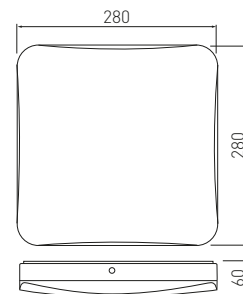

LD-EMP24W-40KW



24 W



● 4000 K



2200 lm



PC/PC



белый



1100 гр



Светодиодный светильник LED EMPOLIO с микроволновым датчиком движения

доступен от января

Светоотдача 90 lm/W

IP 54

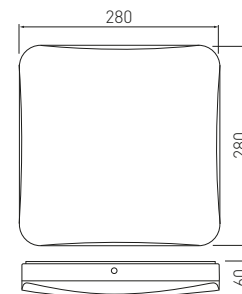

LD-EMP24WM-40KW

24 W

● 4000 K

2200 lm

PC/PC

белый

1100 гр



Указанные сроки доступности могут быть изменены

Светоотдача 90 lm/W

IP 54

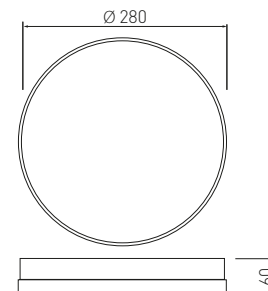

LD-EMP24W-40



24 W



● 4000 K



2200 lm



PC/PC



белый



900 гр



Светодиодный светильник LED EMPOLIO с микроволновым датчиком движения

доступен от января

Светоотдача 90 lm/W

IP 54

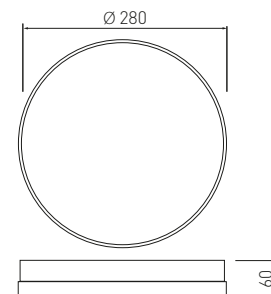

LD-EMP24WM-40

24 W

● 4000 K

2200 lm

PC/PC

белый

900 гр



Указанные сроки доступности могут быть изменены

Отсутствие видимых световых пунктов

Равномерное распределение света

Надежный алюминиевый крепеж

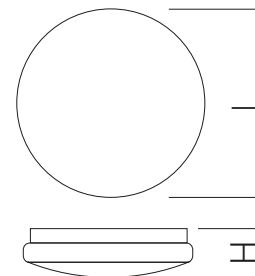

LD-SATU12W-NB	12 W	● 4000 K	IP 44	PF>0,5	900 lm	ø260 × 60	акрил	белый	390 гр
LD-SATU18W-NB	18 W				1300 lm	ø330 × 60			650 гр
LD-SATU24W-NB	24 W				1600 lm	ø380 × 65			1000 гр



Светоотдача 100 lm/W

IP65 / IK10

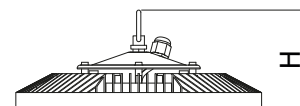
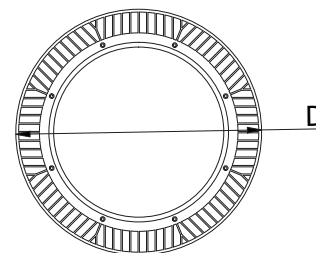

LD-DAL100W-NB	100 W	● 4000 K	10000 lm	алюминий	ø 260 × 104	черный	1600 гр
LD-DAL150W-NB	150 W		15000 lm		ø 300 × 120		2500 гр



Светоотдача 100 lm/W

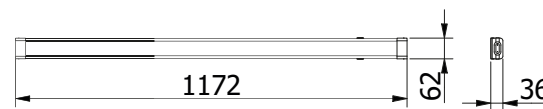

LD-ONT120-36

36 W

7

● 4000 K

3600 lm

PC

белый

470 гр





LD-ONTPWR-00



LD-ONTMCI-00



LD-ONTEND-00



LD-ONTEND-00	белый	20 гр
LD-ONTMCI-00		30 гр
LD-ONTPWR-00		60 гр

Экономия места благодаря небольшому размеру

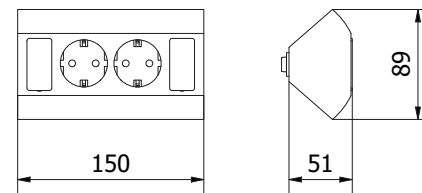

AE-PBKTМ2S-80	schuko		
AE-PBKTМ2F-80	french	серебристый	алюминий, пластик

Экономия места благодаря небольшому размеру

Встроенный переключатель



AE-PBKTМ1SW-80

AE-PBKTМ2FW-80

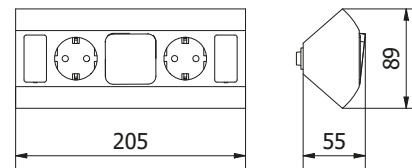
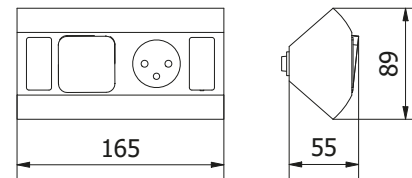

AE-PBKTМ1SW-80	schuko	серебристый	алюминий, пластик
AE-PBKTМ1FW-80	french		
AE-PBKTМ2SW-80	schuko		
AE-PBKTМ2FW-80	french		

Угловой удлинитель MINI с регулятором света цвета

доступен от марта

Встроенный регулятор цвета CCT

Экономия места благодаря небольшому размеру

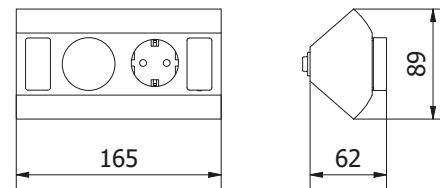

AE-PBKT1SCCT-80	schuko	серебристый	алюминий, пластик
AE-PBKT1FCCT-80	french		

Встроенный переключатель

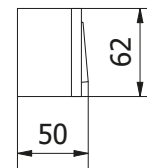
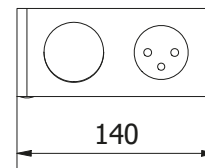

AE-PBOX1SW-80	schuko	серебристый	алюминий, пластик
AE-PBOX1FW-80	french		

Указанные сроки доступности могут быть изменены

Заглушка для утепленного профиля GLAX

доступен от февраля

Новая дизайнерская форма



PA-ZASGLAX-00

2





серый

ABS



Новый материал – отсутствие видимых световых пятен



		 m		
PA-OSMLGLAX-00	2	молочная	PC	
PA-OSMLGLAXMK-00				
PA-OSMLGLAXM-00				
PA-OSMLGLAXMO-00				
PA-OSMLGLAXT-00				
PA-OSMLGLAX3M-00	3			
PA-OSMLGLAXM3M-00				
PA-OSMLGLAXMK3M-00				
PA-OSMLGLAXM03M-00				
PA-OSMLGLAXT3M-00				





PA-CPGLAXL-00



PA-CPGLAXAH-00



PA-CPGLAXAV-00



				
PA-CPGLAXL-00		3	серебристый	алюминиевый
PA-CPGLAXAH-00				
PA-CPGLAXAV-00				

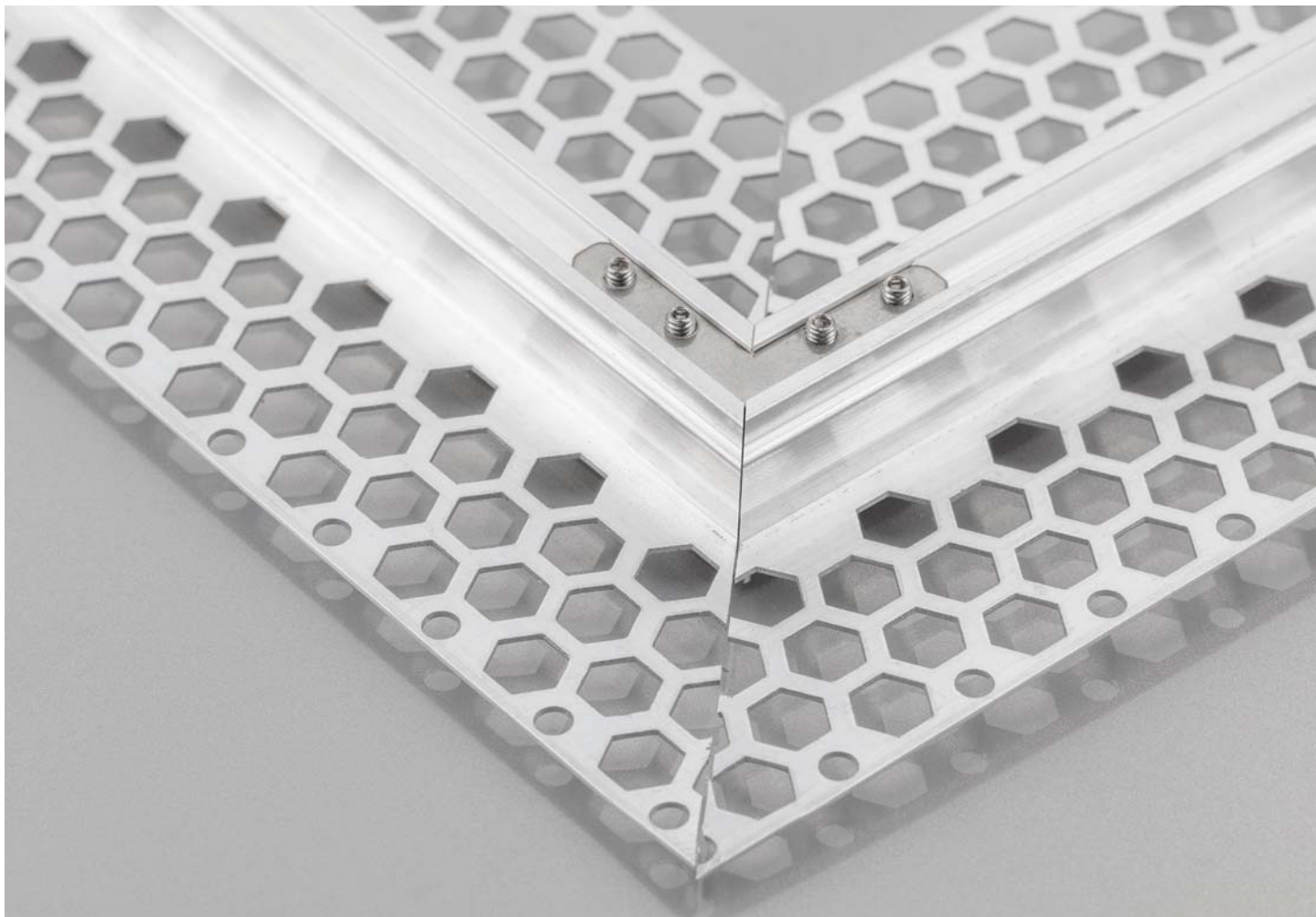

Предназначен для профиля GLAX накладного микро и профиля GLAX углового накладного



PA-SPRGLAXMIC-00



серебряный



сталь



Блок питания LED PRO 80W

доступен от марта

12V

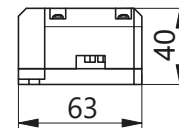
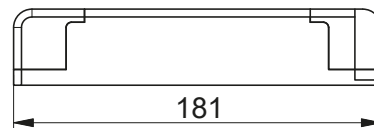

LD-ZASPR080W-30

80W

пластик



Блок питания LED PRO 80W

доступен от марта

24V

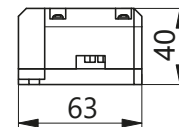
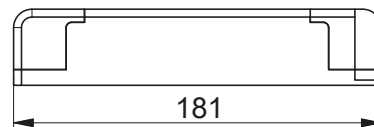

LD-ZAS24PRO80W-30

80 W

пластик



Указанные сроки доступности могут быть изменены

Светодиодная лента LED FLASH 24 V

доступен от марта

➤ Более долгий срок службы ленты, безопасный монтаж – меньшая нагрузка на систему

➤ Отсутствие уменьшения интенсивности света на длинных отрезках ленты

➤ 24V DC

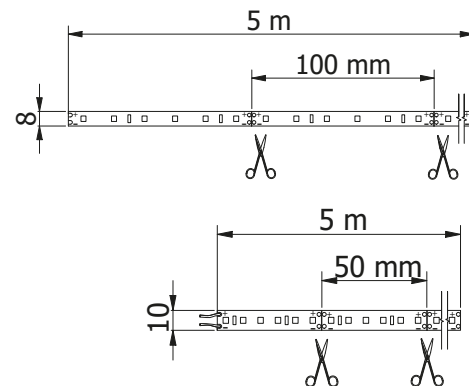

LD-2835-24V-300-20-CB	24 VDC 48 W	780 lm/m	● 3200 K	20	120°	5	8	60/m	10
LD-2835-24V-300-20-ZB			● 6500 K						
LD-2835-24V-300-20-NE4			● 4000 K						
LD-2835-24V-600-20-CB	24 VDC 78 W	1350 lm/m	● 3200 K	20	120°	5	10	120/m	5
LD-2835-24V-600-20-ZB			● 6500 K						
LD-2835-24V-600-20-NE4			● 4000 K						





GTV

ul. Przejazdowa 21
05-800 Pruszków
Poland

 +48 22 44 47 595

 +48 22 44 47 366

 +48 22 44 47 287

 +48 22 44 47 367

 + 48 22 44 47 379

 +420 591 160 091

 +48 22 44 47 338

 +48 22 44 47 338

 +48 22 44 47 338

 +48 22 44 47 338

 +48 22 44 47 338

 +48 22 44 47 338

 +48 22 44 47 338

 +48 22 44 47 338

 +48 22 44 47 338

 +48 22 44 47 338

 000 140073, РФ, «ГТВ РУС»
Московская область,
Люберецкий район, пос.Томлино,
Микрорайон Птицефабрика,
Литер 7А
+ 7 495 640 15 88

 GTV Croatia d.o.o
Kovinska 4a, 10000 Zagreb
Hrvatska
+ 385 1798 8089

 GTV Czech Distribution s.r.o.
CTPark Ostrava, Na Rovince 879
720 00 Ostrava Hrabová
Česká republika
+420 591 160 091

 GTV España Herrajes e Iluminación,
S.L., Avenida Aragón 30, Planta 8
46021 Valencia (España)
+ 34 960 468 666
+ 48 22 44 47 377

fax: +48 22 444 75 01
e-mail: oswietlenie@gtv.com.pl
east.lighting@gtv.com.pl
www.gtv.com.pl

Follow us on



Данный квартальник новинок приготовлен GTV Poland. Постоянно совершенствуя свое предложение в соответствии с требованиями рынка и законодательства, GTV Poland оставляет за собой право вносить изменения в представленный ассортимент. Данная публикация не является предложением в понимании Гражданского кодекса. Актуальные продукты могут отличаться от иллюстраций и рисунков, содержащихся в публикации. GTV Poland оставляет за собой право вносить изменения и ошибок в печати.