



Светодиодный светильник ARGO

Доступен для заказа с июля

Высокая светоотдача - 100 лм / Вт

Современное решение для задней панели

Компактный блок питания

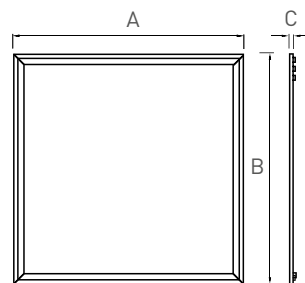

| | | | |
|----------------|------|---------|--------|
| LD-ARG30W60-NB | 30 W | 3000 lm | 1500 g |
| LD-ARG40W60-NB | 40 W | 4000 lm | |
| LD-ARG55W60-NB | 55 W | 5500 lm | |



A

B

C

| | | | |
|----------------|--------|--------|-------|
| LD-ARG30W60-NB | 445 mm | 445 mm | 26 mm |
| LD-ARG40W60-NB | 595 mm | 595 mm | |
| LD-ARG55W60-NB | 595 mm | 595 mm | |



G-TECH Светодиодный светильник 40 Вт

Доступен для заказа с июля

Современное решение для задней панели

Компактный блок питания



GT-PBPL40W606-40



GT-PBPL40W123-40

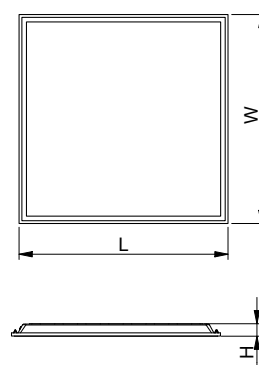

| | |
|------------------|--------|
| GT-PBPL40W606-40 | 1700 g |
| GT-PBPL40W123-40 | 2000 g |



LxWxH
mm

| | |
|-----------------|-------------|
| GT-PBL40W606-40 | 595x595x32 |
| GT-PBL40W123-40 | 1195x295x32 |



G-TECH Рама 45x45 cm

Доступен для заказа с августа

Легкий и быстрый монтаж - не требуются винты для крепления

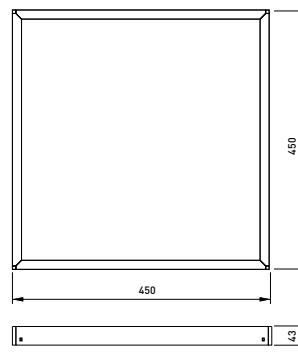

GT-RM45X45-00

400 g



Уличный светодиодный светильник INDIANA

Доступен для заказа с июня

Защита от перенапряжения SPD - 10 кВ

Высокая светоотдача - 130 лм / Вт

Регулируемый монтажный кронштейн



LD-IND150W-40

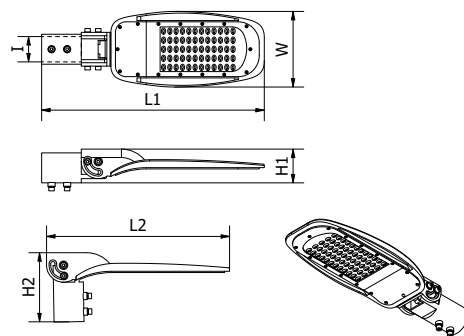

LD-IND60W-40

60 W

7800 lm

LD-IND100W-40

100 W

13000 lm

LD-IND150W-40

150 W

19500 lm



L1

L2

W

H1

H2

I

LD-IND60W-40

525 mm

430 mm

180 mm

80 mm

170 mm

ø 60 mm

LD-IND100W-40

580 mm

485 mm

220 mm

80 mm

170 mm

ø 60 mm

LD-IND150W-40

635 mm

540 mm

250 mm

80 mm

170 mm

ø 60 mm



Возможность изменения цвета света TRI-COLOR

Встроенное индуктивное зарядное устройство

Функция диммирования



TRI-COLOR



LB-IZK6WCCT-00



LB-IZK6WCCT-10



| | | | | |
|----------------|-----|--------|--------------------------|-------|
| LB-IZK6WCCT-00 | 6 W | 400 lm | 3000 K / 4000 K / 6400 K | 520 g |
| LB-IZK6WCCT-10 | | | | |

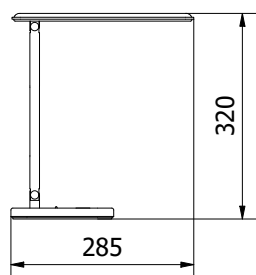



Регулируемая яркость 100% / 50% / 10%

Нейтральный светлый цвет - 4000K

Тонкий, современный дизайн



LB-HAL8W-00-DEC



LB-HAL8W-10-DEC



| | | | | |
|-----------------|-----|--------|-------|--------|
| LB-HAL8W-00-DEC | 8 W | 500 lm | 4000K | 1660 g |
| LB-HAL8W-10-DEC | | | | |

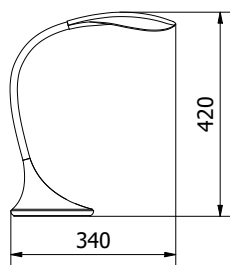
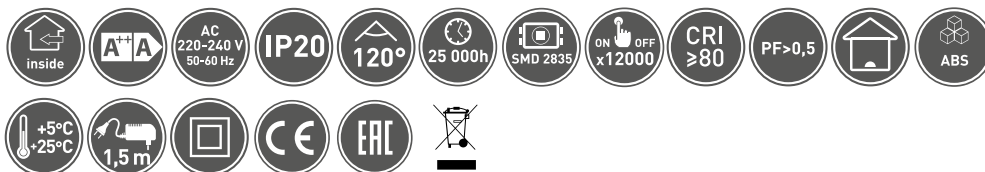



Настольная светодиодная лампа LINEAR

Доступен для заказа с июля

Дополнительные функции: часы, календарь, температура, будильник

Возможность изменения цвета света TRI-COLOR

5 уровней затемнения



LB-LIN7W-00-DEC



LB-LIN7W-10-DEC

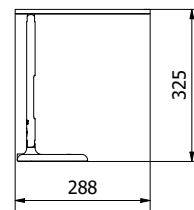

| | | | | |
|-----------------|-----|--------|----------------------|-------|
| LB-LIN7W-00-DEC | 7 W | 420 lm | 2700K- 4500K - 6500K | 750 g |
| LB-LIN7W-10-DEC | | | | |



Настольная светодиодная лампа GALE

Доступен для заказа с июля

Возможность изменения цвета света TRI-COLOR

Плавная регулировка яркости

Функция прикроватной лампы



LB-GAL8W-00-DEC



LB-GAL8W-10-DEC



| | | | | |
|-----------------|-----|--------|--|-------|
| LB-GAL8W-00-DEC | 8 W | 550 lm | 2700 K / 3500 K / 4500 K / 5500 K / 6500 K | 785 g |
| LB-GAL8W-10-DEC | | | | |

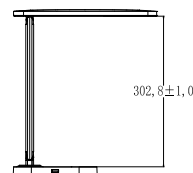



- Возможность изменения цвета света TRI-COLOR
- Прочная металлическая конструкция
- Современный дизайн

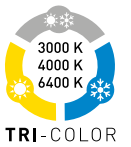

| | | | | |
|------------------|------|--------|-----------------------|-------|
| LB-LON12W-10-DEC | 12 W | 700 lm | 3000K - 4000K - 6000K | 875 g |
|------------------|------|--------|-----------------------|-------|

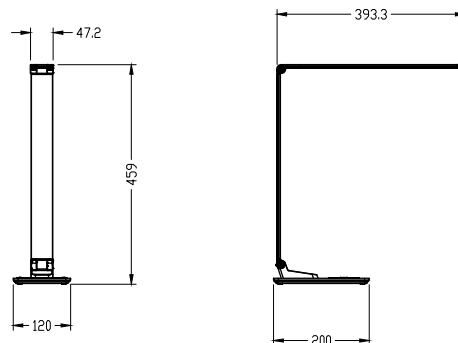



Функция автоматического отключения

Встроенное индуктивное зарядное устройство

Сенсорная панель управления



FOUR - CO LOR



LB-TRIT6W-00-DEC



LB-TRIT6W-10-DEC



| | | | | |
|------------------|-----|--------|-------------------------------|-------|
| LB-TRIT6W-00-DEC | 6 W | 340 lm | 2700K - 3000K - 4000K - 6000K | 800 g |
| LB-TRIT6W-10-DEC | | | | |

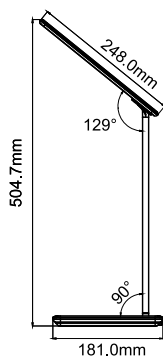



Идеально подходит для комнаты каждого детского сада

Доступен в 4 цветах



LB-HEL6W-25-DEC



LB-HEL6W-20-DEC



LB-HEL6W-15-DEC



LB-HEL6W-00-DEC



| | | | | |
|-----------------|-----|--------|-------|-------|
| LB-HEL6W-25-DEC | 6 W | 350 lm | 4000K | 800 g |
| LB-HEL6W-20-DEC | | | | |
| LB-HEL6W-15-DEC | | | | |
| LB-HEL6W-00-DEC | | | | |

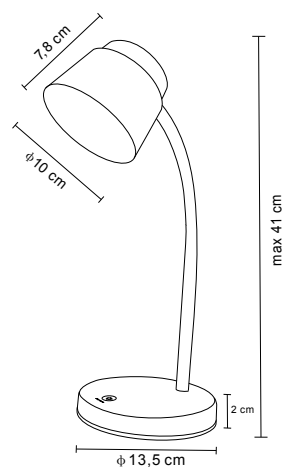



Функция автоматического отключения

Встроенное индуктивное зарядное устройство

Сенсорная панель управления



LB-BRE8W-11-DEC



LB-BRE8W-15-DEC



| | | | | |
|-----------------|-----|--------|--------------------------|-------|
| LB-BRE8W-11-DEC | 8 W | 450 lm | 3000 K / 4000 K / 6400 K | 750 g |
| LB-BRE8W-15-DEC | | | | |

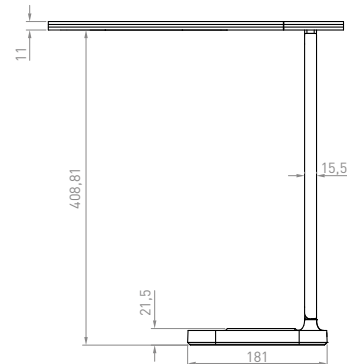
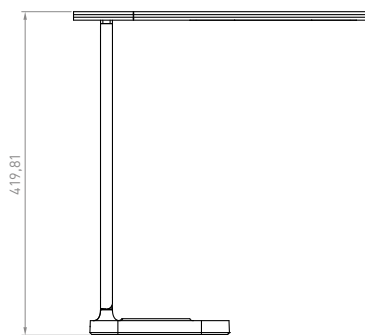
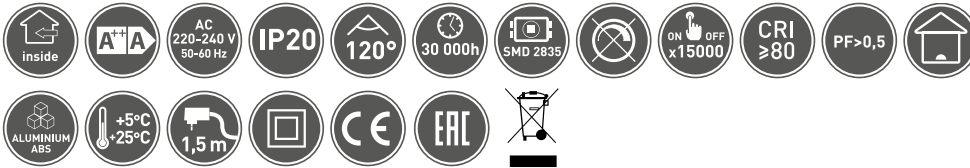





- Наклон светильника можно регулировать
- Высокая светоотдача - 100 лм / Вт
- Угол свечения 36 градусов



LD-BNC15WKB-NB



LD-BNC15WKC-NB



LD-BNC15WOB-NB



LD-BNC15WOC-NB

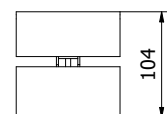
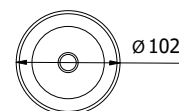
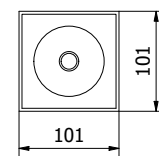

| | | | |
|----------------|------|---------|-------|
| LD-BNC15WKB-NB | 15 W | 1500 lm | 680 g |
| LD-BNC15WKC-NB | | | 680 g |
| LD-BNC15WOB-NB | | | 600 g |
| LD-BNC15WOC-NB | | | 600 g |



Потолочный светильник ASTER

Доступен для заказа с сентября

- Предназначен к источникам GU10
- Возможность регулировки угла рассеивания света
- Современный дизайн



| | |
|---------------|----------|
| OS-AS1GU10-00 | max 50 W |
| OS-AS1GU10-10 | |
| OS-AS2GU10-00 | |
| OS-AS2GU10-10 | |





Потолочный светильник ARALIA

Доступен для заказа с июля

Предназначен к источникам G9

Угол наклона светильника можно регулировать

Современный дизайн

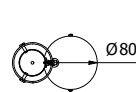

OS-AR1G9 - 10

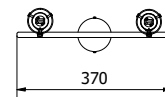

OS-AR2G9 - 10

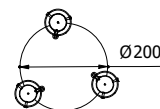

OS-AR3G9 - 10

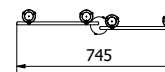

OS-AR4G9 - 10

| Model | Power | Weight |
|---------------|--------------|--------|
| OS-AR1G9 - 10 | max 20 W | 225 g |
| OS-AR2G9 - 10 | max 2 x 20 W | 485 g |
| OS-AR3G9 - 10 | max 3 x 20 W | 725 g |
| OS-AR4G9 - 10 | max 4 x 20 W | 836 g |



Потолочный светильник VENETO

Доступен для заказа с сентября

Предназначен к источникам GU10

Современный и минималистичный дизайн

Доступен в трех размерах

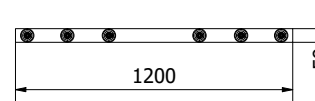
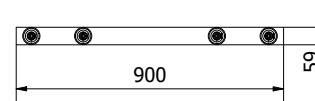
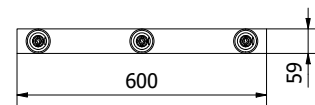

| Model | Power | Weight |
|-----------------|--------------|--------|
| OS-VEN20WKW3-10 | max 3 x 20 W | 880g |
| OS-VEN20WKW3-00 | | |
| OS-VEN20WKW4-10 | max 4 x 20 W | 1220g |
| OS-VEN20WKW4-00 | | |
| OS-VEN20WKW6-10 | max 6 x 20 W | 1740g |
| OS-VEN20WKW6-00 | | |





Потолочный точечный светильник ELVA

Доступен для заказа с июля

Подходит для помещений с повышенной влажностью (IP54)

Надежная алюминиевая конструкция

Богатая цветовая палитра



| OP-ELVAOBB-10 | | max. 20 W | 145 g |
|---------------|--|-----------|-------|
| OP-ELVAOCC-00 | | | |
| OP-ELVAOBC-11 | | | |
| OP-ELVAOBM-13 | | | |
| OP-ELVAOCM-03 | | | |

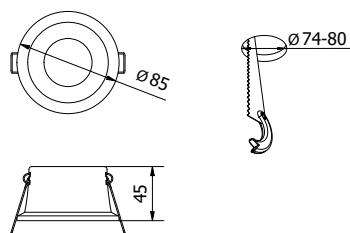

Садовый светильник GRAZIE

Доступен для заказа с июля

1,5 м шнур питания с вилкой в комплекте

Доступен в двух цветах: черном и inox

Возможность регулировки угла рассеивания света

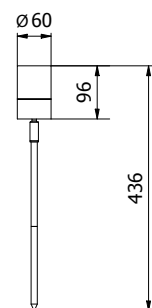

| OS-GRAZIEGU10-20 | | max 20 W | 740 g |
|------------------|--|----------|-------|
| OS-GRAZIEGU10-01 | | | |





- Предназначен к источникам GU10
- Возможность регулировки угла рассеивания света
- Уникальный дизайн



OS-USTI0UD-30



OS-USTIP40-30



OS-USTIP80-30

|  |  |  |
|---|---|---|
| OS-USTI0UD-30 | max 25 W | 435 g |
| OS-USTIP40-30 | | 790 g |
| OS-USTIP80-30 | | 1140 g |

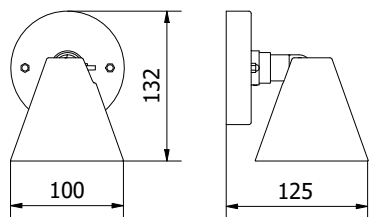

OS-USTI0UD-30

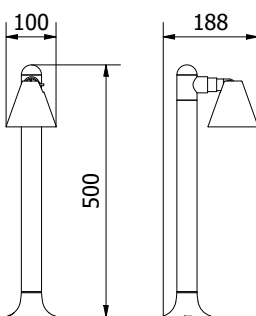

OS-USTIP40-30

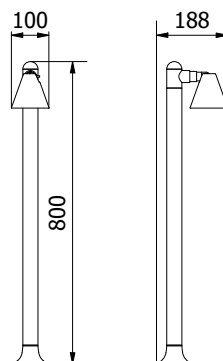

OS-USTIP80-30

- Предназначен к источникам E27
- Низкий столб доступен со встроенной розеткой
- Комплексное решение для современного сада или приусадебного участка



OS-LARG0UA-30



OS-LARGP40-30



OS-LARGP40G-30



OS-LARGP80-30

| Icon: Folder | Icon: Wattmeter | Icon: Weight |
|----------------|-----------------|--------------|
| OS-LARG0UA-30 | max 15 W | 450 g |
| OS-LARGP40-30 | | 820 g |
| OS-LARGP80-30 | | 1120 g |
| OS-LARGP40G-30 | | 990 g |

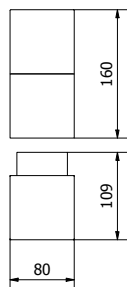

OS-LARG0UA-30

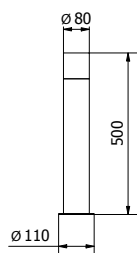

OS-LARGP40-30

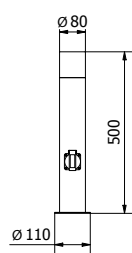

OS-LARGP80-30

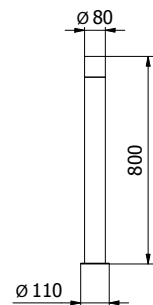

OS-LARGP40G-30

- Уровень защиты IP65 позволяет установку на открытом воздухе
- Уникальный дизайн
- Два варианта форм на выбор



LD-CANTI12WOK-40

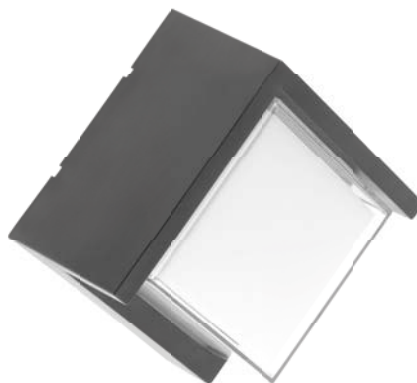

LD-CANTI12WKW-40

| LD-CANTI12WOK-40 | 12 W | 1000 lm | PC | 510 g |
|------------------|------|---------|----|-------|
| LD-CANTI12WKW-40 | | | | 600 g |



LD-CANTI12WOK-40

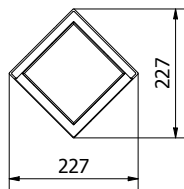

LD-CANTI12WKW-40

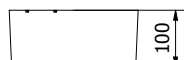

GTV

ul. Przejazdowa 21
05-800 Pruszków
Poland

 +48 22 44 47 595

 +48 22 44 47 366
+48 22 44 47 287

 +48 22 44 47 367

 + 48 22 44 47 379

 +420 591 160 091



 +48 22 44 47 338





 +48 22 44 47 552
+48 69 48 08 544

 ООО «ГТВ РУС»
109428, г. Москва, Рязанский проспект, дом 8А,
строение 7
тел: 8-495-640 15 88
info@gtv-rus.com.ru

 GTV Croatia d.o.o
Kovinska 4a, 10000 Zagreb
Hrvatska
+ 385 1 798 8089

 GTV Czech Distribution s.r.o.
CTPark Ostrava, Na Rovince 879
720 00 Ostrava Hrabová
Česká republika
+420 591 160 091

 GTV España Herrajes e Iluminación,
S.L., Avenida Aragón 30, Planta 8
46021 Valencia (España)
+ 34 960 468 666
+ 48 22 44 47 377

fax: +48 22 444 75 01

e-mail: oswietlenie@gtv.com.pl
east.lighting@gtv.com.pl

www.gtv.com.pl

Follow us on



Данный квартальник новинок подготовлен GTV Poland. Постоянно совершенствуя свое предложение в соответствии с требованиями рынка и законодательства, GTV Poland оставляет за собой право вносить изменения в представленный ассортимент. Данная публикация не является предложением в понимании Гражданского кодекса. Актуальные продукты могут отличаться от иллюстраций и рисунков, содержащихся в публикации. GTV Poland оставляет за собой право вносить изменения и ошибки в печати.